

# MAHLE

# 2020

## Instructions for suppliers in the business of packaging

**DEVELOPMENT**  
INNOVATIVE  
SOLUTIONS

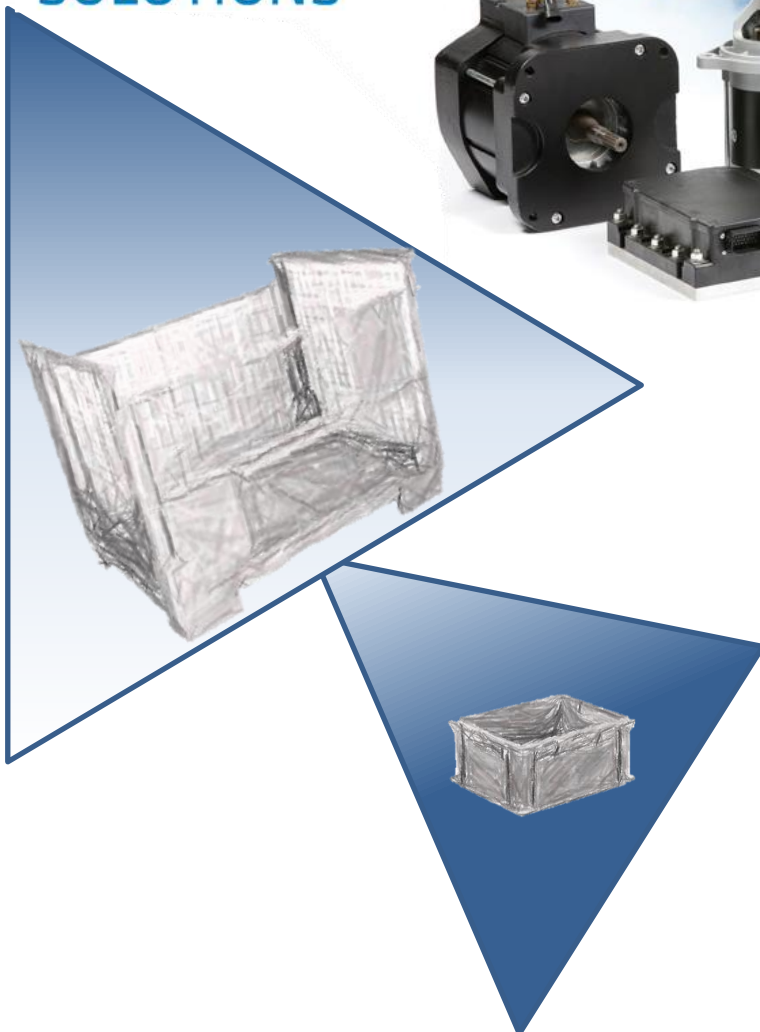

**Packaging  
guidelines for  
suppliers**

**MAHLE Electric Drives Slovenija  
d.o.o.**



## CONTENTS

|       |  |    |
|-------|--|----|
| 1     | Preface  | 5  |
| 1.1   | Manual purpose   | 5  |
| 1.2   | Supplier's responsibility                                | 5  |
| 1.3   | The process of defining appropriate packaging            | 6  |
| 1.4   | Suppliers quality day                                    | 6  |
| 2     | The process of defining the returnable packaging         | 6  |
| 2.1   | Development phase  | 6  |
| 2.2   | Test phase   | 9  |
| 2.3   | Production phase   | 10 |
| 3     | Changing a predefined returnable packaging               | 10 |
| 4     | Packaging instructions                                   | 10 |
| 4.1   | Process description                                      | 10 |
| 4.2   | Content of packaging instruction                         | 11 |
| 5     | Standards  | 12 |
| 5.1   | General requirements and definition                      | 12 |
| 5.1.1 | Returnable packaging                                     | 12 |
| 5.1.2 | One-way packaging  | 12 |
| 5.1.3 | Packaging unit   | 12 |
| 5.1.4 | Handling unit  | 13 |
| 5.2   | Weight and dimensions                                    | 13 |
| 5.3   | Stacking and protecting the packaging and handling unit  | 14 |
| 5.4   | Delivery documentation                                   | 15 |
| 5.5   | Recycling and environmental requirements                 | 15 |
| 6     | Marking and labelling of packaging units                 | 16 |
| 6.1   | Marking the first samples and special deliveries         | 16 |
| 6.2   | Marking - labelling manipulation and packaging units     | 17 |
| 6.3   | Marking mixed manipulation and packaging unit            | 18 |
| 6.4   | Programme for labelling manipulation and packaging units | 18 |
| 6.4.1 | Fonts installation                                       | 19 |
| 6.4.2 | Programme installation                                   | 19 |
| 6.4.3 | Programme description                                    | 19 |
| 6.4.4 | Address check  | 20 |
| 6.4.5 | Printing   | 21 |

|        |  |    |
|--------|--|----|
| 6.4.6  | .....Reprinting.....   | 22 |
| 6.4.7  | .....Entry of a new material code .....                          | 23 |
| 6.4.8  | .....Correcting the current ident data .....                     | 23 |
| 6.4.9  | .....History overview .....                                      | 24 |
| 6.4.10 | .....Correcting output settings .....                            | 24 |
| 6.4.11 | .....Exit programme .....  | 25 |
| 6.4.12 | .....Error types .....   | 25 |
| 7      | .....Process of management of returnable packaging .....         | 26 |
| 7.1    | .....MAHLE Electric Drives Slovenija provided packaging .....    | 26 |
| 7.1.1  | .....Loop size calculation .....                                 | 26 |
| 7.1.2  | .....Formula and parameters for calculation.....                 | 27 |
| 7.1.3  | .....The procurement and financing of returnable packaging ..... | 28 |
| 7.1.4  | .....Delivery packagings to supplier .....                       | 28 |
| 7.1.5  | .....Supplier's packagings takeover .....                        | 28 |
| 7.1.6  | .....Packagings status supplier .....                            | 28 |
| 7.1.7  | .....Inventory .....   | 29 |
| 7.1.8  | .....Hygiene of returnable packaging .....                       | 29 |
| 7.2    | .....Supplier's packaging.....                                   | 29 |
| 8      | .....Air freight.....  | 29 |
| 8.1    | .....Introduction .....  | 29 |
| 8.2    | .....Hazards of distribution.....                                | 30 |
| 8.3    | .....Marking and labelling shipments .....                       | 30 |
| 8.4    | .....Cardboard cartons .....                                     | 31 |
| 8.5    | .....Pyramid-shaped loads.....                                   | 31 |
| 8.6    | .....Wood packages.....  | 31 |
| 8.7    | .....Air freight pallets .....                                   | 31 |
| 8.8    | .....Dunnage.....  | 32 |
| 8.9    | .....Cushioning.....   | 32 |
| 8.10   | .....Stretch wrapping .....                                      | 32 |



# 1 PREFACE

## 1.1 Manual purpose

This manual is intended for suppliers that choose new packaging or replace the existing one so as to be suitable for MAHLE Electric Drives Slovenija plants and for the supplier. The manual offers guidelines to all involved into the packaging process. These standards are necessary to ensure general accountability to maintain quality performance and reduce costs. This manual can be updated by additional requirements of the MAHLE Electric Drives Slovenija receiving facility.

## 1.2 Supplier's responsibility

- Supplier is responsible for appropriate packaging. Goods must be packed in such a way that they do not break or damage, from the manufacturing source to the point of use in MAHLE Electric Drives Slovenija .
- In choosing packaging, the safety of worker must be considered. Packaging weight must not exceed 12 kg, and should enable manual handling by of one person.
- Dimensions of a packaging unit must be the lowest possible with regards to the assembly line or linefeed and not more than 600x400x480.
- Packaging design must protect the product.
- Supplier is responsible for correct labeling.
- In the process of continuous improvement in MAHLE Electric Drives Slovenija the packaging can be changed. Supplier shall respond to the request and manage new packaging changes.
- The returnable MAHLE Electric Drives Slovenija packagings are preferred, in some cases one-way packagings can be used, which must be recyclable.

### Additional supplier responsibilities in the case of MAHLE Electric Drives Slovenija provided returnable packaging.

- Supplier is responsible for keeping records of returnable packagings in and out of the supplier location. In case of deviations of number of packagings, the supplier must inform MAHLE Electric Drives Slovenija .
- The supplier must have enough stock of packaging.
- The supplier is responsible to do annual report of the packaging condition. The report includes number of packagings with possible deviations and conditions of packagings. In case of damage or lost packaging at the supplier location, MAHLE Electric Drives Slovenija will charge the supplier.
- Each supplier must develop a contingency plan for alternative packaging, which has to be approved by MAHLE Electric Drives Slovenija .

### 1.3 The process of defining appropriate packaging

MAHLE Electric Drives Slovenija and the supplier will choose the most appropriate packaging together. The process of defining a new packaging has got development, testing and production phase.

Firstly, both parties choose the packaging, then the tests and confirmation follow.

The supplier must consider a protection of a product inside of the packaging unit to prevent any damage during transportation.

### 1.4 Suppliers quality day

On the Suppliers quality day of MAHLE Electric Drives Slovenija the respect of agreement of packaging will be considered. Assessment will be made in respect of the prescribed packaging and labelling. Suppliers will be able to introduce all the problems regarding the returnable packaging.

## 2 THE PROCESS OF DEFINING THE RETURNABLE PACKAGING

Packaging has to be defined with material when:

- A new product is in the development phase
- Material does not have packaging defined
- Packaging instructions for the material in the system do not exist

### 2.1 Development phase

In the development stage of raw material, MAHLE Electric Drives Slovenija will choose the appropriate returnable packaging for the supplier or will give the requirements for new packaging. If the new packaging does not suit the supplier, he can choose it from the catalogue with agreement of MAHLE Electric Drives Slovenija . The supplier must comply with the requirements predefined by MAHLE Electric Drives Slovenija . Then the agreement with both parties is made. Exceptionally when supplier does not meet the packaging in the Catalogue, a new packaging can be developed taking into account the given restrictions.

The supplier can propose a non-returnable packaging, which is fully covered by the supplier.

The goods inside the packaging must be protected to avoid damage during transportation.

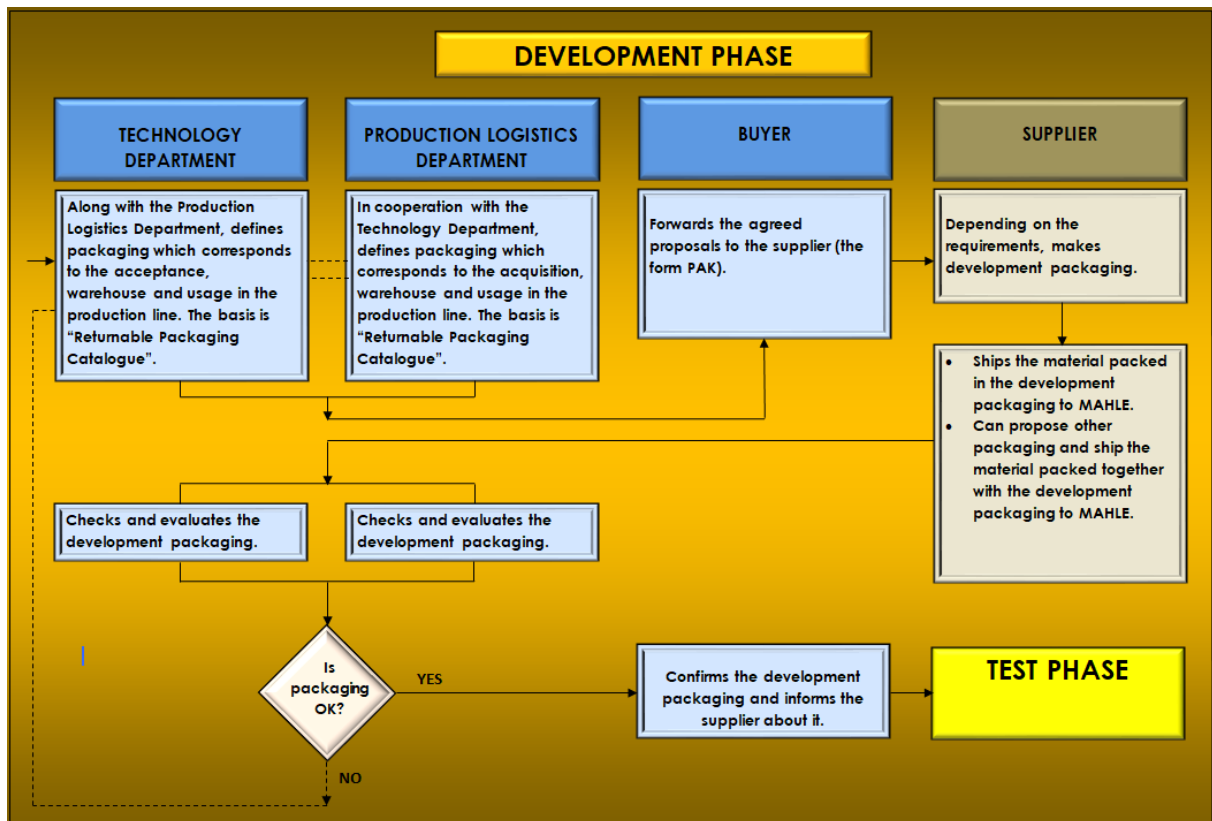

In defining packaging and packing we have two possibilities:

#### Basic development for »an unknown part«

- A technologist chooses appropriate packaging, which he wants at a workplace on the shop floor. After compliance with the supplier, he creates instruction for the new part in the Information system packing. Basic packaging must be appropriate for a workplace. Solutions can be found in the Catalogue of returnable packaging in standardization and unification paragraph.
- Production logistics department in cooperation with the technologist defines handling operations in warehouse business and production supply. In addition, it defines all packaging levels and palletisation. The aim is that the supplier sends goods in such packaging that there is no further need to repack the basic packagings for storing in warehouses and supply the shop floor.
- Packaging proposals are sent via Purchasing Division to potential suppliers.

#### Basic or applicative development for »design and purpose known part«

(For example: new rotor, by design same as the existing.)

- Technologist chooses packaging by known principles.
- Technologist creates packing instruction with the link STOC for a new part.
- Packaging and development is driven directly through the PPAP process.
- Coordination with the existing suppliers is minimal.

**In the development phase MAHLE Electric Drives Slovenija will provide the form »PAK« to the supplier.**



In this form we can see material and packaging. Here ownership and some packaging requirements are written.



## PACKAGING INFORMATION

**GENERAL INFORMATION**

|  |                  |               |              |      |
|--|------------------|---------------|--------------|------|
| COMPANY / ADDRESS / ZIP<br><b>MAHLE Electric Drives Slovenija d.o.o. / POLJE 15 / 5290</b> |                  | PHONE NUMBER  | E-MAIL / FAX | DATE |
| PART NUMBER  | PART DESCRIPTION | ANNUAL VOLUME |              |      |

**PACKAGE TYPE**

Expendable packaging  
  Supplier returnable & expendable packaging  
  Supplier returnable packaging  
  MAHLE Electric Drives Slovenija packaging

| SPECIAL PACKAGING REQUIREMENTS  | ADDITIONAL COMMENTS |
|---|---------------------|
| <input type="checkbox"/> Part Orientation Critical (Additional Comments *)<br><input type="checkbox"/> Packaging Unit / gross weight no limited to 15kg<br><input type="checkbox"/> Contact between part/products is not allowed<br><input type="checkbox"/> Packing unit must have lids<br><input type="checkbox"/> Protection products with inserts<br><input type="checkbox"/> Part cleanliness is an issue<br><input type="checkbox"/> Restriction of part movement<br><input type="checkbox"/> ESD protection Req'd<br><input type="checkbox"/> Pallet Box Side Access |                     |

*Completed by MAHLE Letrika*

Responsible/  
contact person

|            |            |             |             |
|------------|------------|-------------|-------------|
| Name _____ | Date _____ | Phone _____ | Email _____ |
|------------|------------|-------------|-------------|

**INFORMATION OF RETURNABLE & EXPENDABLE MAHLE PACKAGING**

| PRIMARY PACKAGING (packaging unit)  | IDENTIFICATION NUMBER | L / W / H (mm) | TARE (kg) | MATERIAL |
|-------------------------------------|-----------------------|----------------|-----------|----------|
|                                     | (n/a)                 | (n/a)          |           |          |
| ADDITIONAL PACKAGING / PROTECTION   | IDENTIFICATION NUMBER | L / W / H (mm) | TARE (kg) | MATERIAL |
| (n/a)                               |                       |                |           | (n/a)    |
| ADDITIONAL PACKAGING / PROTECTION   | IDENTIFICATION NUMBER | L / W / H (mm) | TARE (kg) | MATERIAL |
| (n/a)                               |                       |                |           | (n/a)    |
| ADDITIONAL PACKAGING / PROTECTION   | IDENTIFICATION NUMBER | L / W / H (mm) | TARE (kg) | MATERIAL |
| (n/a)                               |                       |                |           | (n/a)    |
| ADDITIONAL PACKAGING / PROTECTION   | IDENTIFICATION NUMBER | L / W / H (mm) | TARE (kg) | MATERIAL |
| (n/a)                               |                       |                |           | (n/a)    |
| SECONDARY PACKAGING ( pallet , etc) | IDENTIFICATION NUMBER | L / W / H (mm) | TARE (kg) | MATERIAL |
|                                     |                       |                |           |          |

Procedure of filling in tab instructions:

### Instructions for completing the form "PAK"

**Completed by MAHLE Electric Drives Slovenija .**

**1. Header "PAK"**

- a) COMPANY / ADDRESS / ZIP : data already entered
- b) PHONE NUMBER: data already entered
- c) E-MAIL / FAX : data already entered
- d) DATE : Starting date of completion the form "PAK"
- e) PART NUMBER : Enter the MAHLE article number, which is preparing / completing the form
- f) PART DESCRIPTION : Product Description (cover,regulator, Etc.)
- g) ANNUAL VOLUME : Estimated or actual annual volume of the item.

**2. PACKAGE TYPE ( You can choose only one option - depending on the selected option, fills the fields in the form "PAK")**

## 2.2 Test phase

### Basic development – new packaging for completely new design and purpose of new parts.

In coordination with a supplier a new packaging is tested. After the final reconciliation the documents of the packaging are made in the information system. In this phase the technology department forwards a demand for development (PPAP process) to the purchasing department (forward to the supplier) . On the first regular shipment (can be done with the PPAP examples), re-examination of appropriateness of the pack is being made to solve possible problems.

### Basic development or application development - packaging design and the purpose of the part is already known.

On the first regular shipment from the supplier to MAHLE Electric Drives Slovenija , adequacy of the packaging is checked on acquisition, storage and on the assembly line in MAHLE Electric Drives Slovenija .

If the packaging meets all the criteria, MAHLE Electric Drives Slovenija and the Supplier confirm it with a »packaging annex«. Upon signature, the production phase can start.

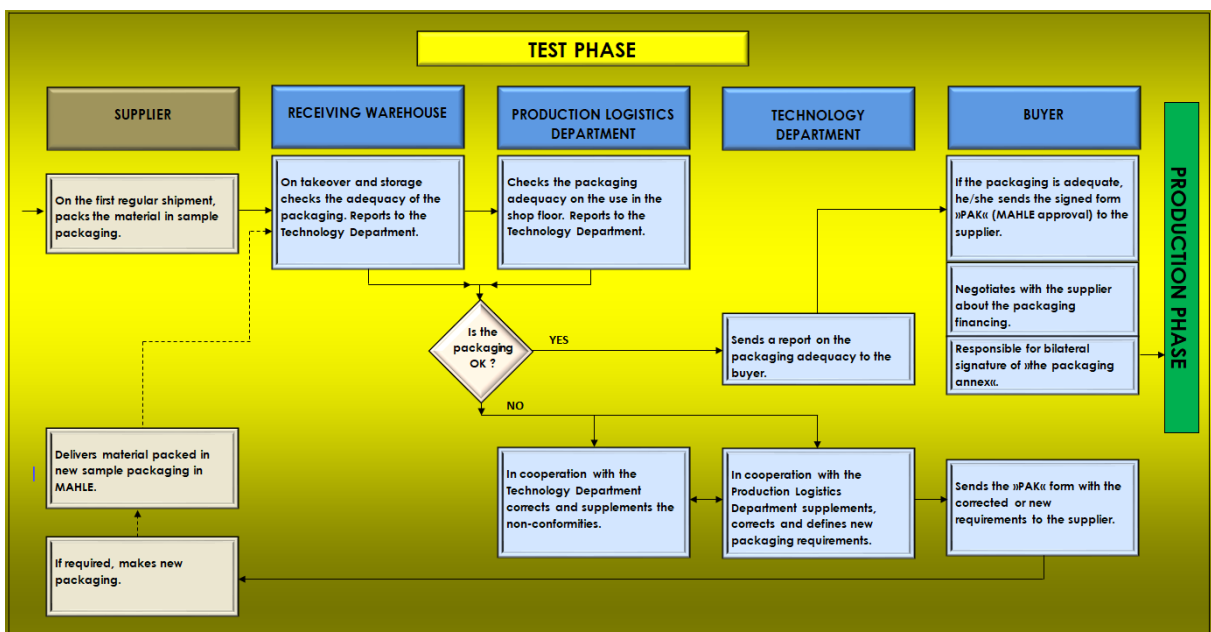

## Annex of packaging

| NP ID |          | Material |  | Količina pakiranja | EM       | VN | Lst   | K | ID.Embalaze | Naziv        | Embalaze Dimenzije | Štalo | Tara   | EAN    | Vrsta od   |            |
|-------|----------|----------|--|--------------------|----------|----|-------|---|-------------|--------------|--------------------|-------|--------|--------|------------|------------|
| 01    | 10001237 | jamnica  |  | 50                 | K 0 1    | V  | 1AE   | 1 | 799000002   | okrog PIRBRO | 500x400x220 VRAF   | 420   | 340    |        | 19.02.2013 |            |
|       |          |          |  |                    | 0004104  |    |       |   | 0020917     | 040          | 300                | 220   | 13,300 | 3,300  |            |            |
|       |          |          |  |                    |          | V  | D 0 0 | 4 | 799002105   | valjast      | 400                | 400   | 5      | 13,300 | 3,300      | 19.02.2013 |
|       |          |          |  |                    | 10000010 |    |       |   | 0020917     | 000          | 400                | 5     | 13,300 | 3,300  |            |            |
|       |          |          |  |                    |          | K  |       | 4 | 799001102   | valjast      | 500x500x5          |       |        |        | 19.02.2013 |            |
|       |          |          |  |                    | 10000001 |    |       |   | 0020917     | 000          | 500                | 5     | 13,300 | 3,300  |            |            |
| 02    |          |          |  | 50                 | K 0 1    | V  | 1AE   | 1 | 799000208   | okrog PDL    | 175x110x100        | 110   | 110    |        | 19.02.2013 |            |
|       |          |          |  |                    | 0001240  |    |       |   | 0020917     | 000          | 100                | 100   | 11,000 | 7,200  |            |            |

Podpis/Datum: \_\_\_\_\_ (Odgovorna oseba)

Podpis/Datum: \_\_\_\_\_ (Dobavitelj)

Legenda: NP - Nova pakiranja    VN - Valjast, Nemaščica    embalaže    TE - Dokument embalaže    K - Količina embalaže    v kosih  
 01 - Baza meta    LST - Lastništvina    embalaže    TF - Dokument pakiranja    Tala so v kg    Dimenzije so v mm

## 2.3 Production phase

In this phase all the documents of packing and packagings must be made and entered into the information system.

## 3 CHANGING A PREDEFINED RETURNABLE PACKAGING

Material, the packaging of which has to be defined is:

- Material is already developed.
- Packaging is determined.
- There is a packaging instruction in the system.

Process changes are implemented in the same way as in defining new returnable packaging.

## 4 PACKAGING INSTRUCTIONS

### 4.1 Process description

When the accordance of packaging between the supplier and MAHLE Electric Drives Slovenija is achieved, the packaging instructions in MAHLE Electric Drives Slovenija are made. Packaging instructions are linked to the annex of the contract of packaging. The supplier can see the packaging or packaging instruction in the annex made in MAHLE Electric Drives Slovenija .

## 4.2 Content of packaging instruction

1. Supplier code and name
2. Standard packaging instruction
3. Sub-packaging instruction
4. Part number and quantity
5. TE and TF document

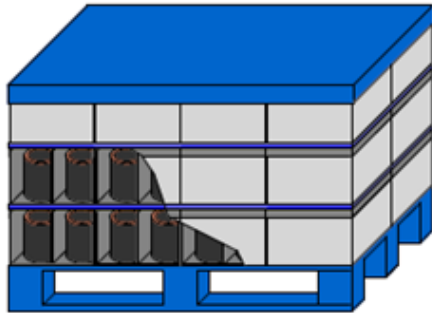

**Handling unit – Packaging instruction**

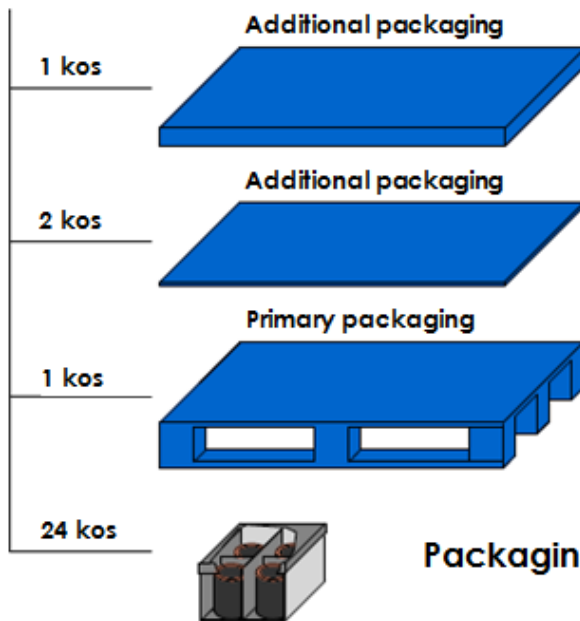

**Packaging unit – Sub-packaging instruction**

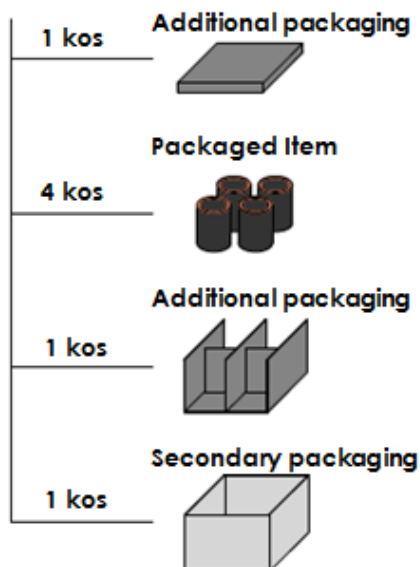

## 5 STANDARDS

### 5.1 General requirements and definition

#### 5.1.1 Returnable packaging

Wherever possible and reasonable from an economic point of view, returnable packaging is preferred. Returnable packaging must be capable of being used for multiple return trips. Its design requires:

- Stackability
- Preferably collapsibility into smaller volume to save space
- Durability and washability, lightweight and firmness
- Ability to be easily filled and emptied
- Ability to be attached to pallets for easy lifting and handling manually.

#### 5.1.2 One-way packaging

When application of returnable packaging is not reasonable or possible, one-way packaging shall be selected.

Therefore the one-way packaging is required to be:

- Stackable.
- Environmentally friendly.
- Able to be emptied quickly.
- Able to provide protection against corrosion and all types of damages.

#### 5.1.3 Packaging unit

A packaging unit represents the smallest unit in which the ordered quantity is packed. The packaging unit can be MAHLE Electric Drives Slovenija 's returnable, supplier's or one-way packaging unit.



### 5.1.4 Handling unit



A handling unit consists of packaging unit and can contain other additional packaging. It must ensure mechanical manipulation. The handling unit must be labelled.

### 5.2 Weight and dimensions

MAHLE Electric Drives Slovenija requires usage of HU base dimensions 1200 x 800 (mm) and/or 800 x 600 (mm) to ensure best transportation usage and mechanical manipulation inside MAHLE Electric Drives Slovenija .

Total height of handling unit must not exceed 1m.



Total weight of one packaging unit must not exceed 12 kg to ensure manipulation by one person. Some receiving facilities in MAHLE Electric Drives Slovenija are designed in the way that 12 kg can be exceeded. On the other hand some materials used in MAHLE Electric Drives Slovenija exceed 12 kg so the rule cannot be followed in the packaging unit.

Packaging unit must be designed in the way that maximum space is used in it and there is no empty space. By doing so, other requirements must be followed as mentioned early.

### 5.3 Stacking and protecting the packaging and handling unit.

Packaging must be fixed and prevented from moving. Incomplete layers must be avoided. PP or metal strap shall be used to fix packaging units due to safety reasons. Packagings shall be covered and wrapped with stretch foil.

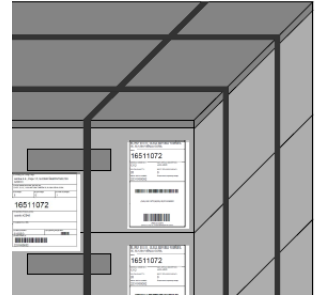

The figure shows an example of stacking the various items on a pallet for mixed codes A, B and C.

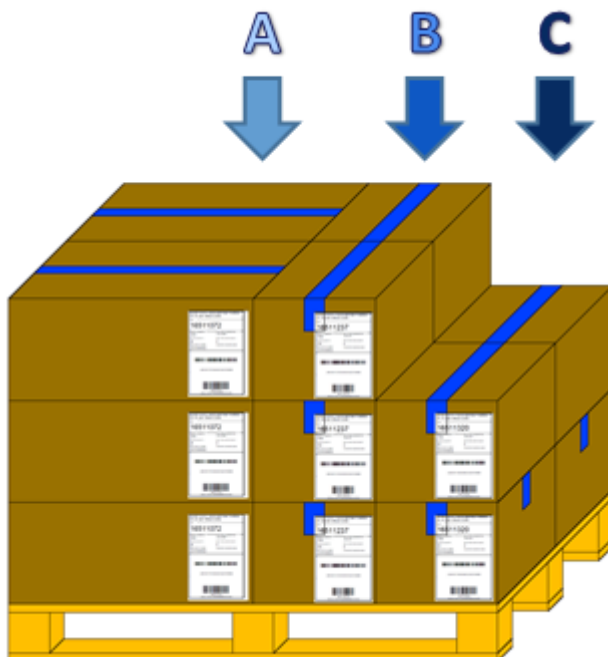

It should be ensured that on the pallet there are not different batches for the same products .

In the event that occurs the same product with two batches is on one pallet, we need each batch folded together and provide access to each batch without reloading other.

In the case of two or more batches each manipulation unit or each box must be specially marked with ODETTE or logistic label.

If possible, keep to the rules of one batch on one pallet.

## 5.4 Delivery documentation

Packaging units must contain documentation that comprises information about the supplier name, ident number packing quantity of receiving material. Also the packagings shall have a date of delivery and date of production. In the packaging documentation shall also include the ident of the returnable MAHLE Electric Drives Slovenija packaging.

## 5.5 Recycling and environmental requirements

Packaging shall be planned taking into account basic economic and ecological requirements.

Some basic rules are:

- The best way to reduce the packaging waste is to reduce the total amount of packagings.
- Reduction of numerous one-way packaging materials used by the supplier.
- Recycling – Returnable or one-way packaging must be made of recyclable materials.

The European Union is seeking to harmonize measures about environmental requirements.

Environmental requirements regarding packaging materials must comply with the »European communities Directive 94/62/EC.«

MAHLE Electric Drives Slovenija will be considering the European directive when planning new returnable packaging. To avoid environment pollution, we use eco-friendly materials, which can be recycled and for this reason they are marked with such international symbol. Every arrow has a meaning that is: **Collect! Process! Reuse!**



For returnable packaging mainly plastic materials are used. Label of the type or to say the chemical composition of the material is a triangle with three arrows and a number in the middle. Below the triangle there can also be initials of the material.





## 6 MARKING AND LABELLING OF PACKAGING UNITS

Unless otherwise agreed between MAHLE Electric Drives Slovenija and the supplier the ODETTE labelling standard is used.

Every transport unit must have transportation label and also every packaging unit must have a label which shall contain:

- Manufacturer's name
- Material name
- Order number
- MAHLE Electric Drives Slovenija 's ident
- Quantity number

Labelling of the goods ordered is the integral part of the contracts and annexes to the contracts between MAHLE Electric Drives Slovenija and the supplier.

All chemicals must be given on each packaging unit as prescribed by the Law on chemicals and safety data sheet.

### 6.1 Marking the first samples and special deliveries

The supplier must label the first samples with yellow label and complete it with the required data hereinafter:

|  |   |
|--|---|
| <b>DOBAVITELJ / SUPPLIER</b>   | <b>PREJEMNIK / RECIPIENT</b><br><b>MAHLE Electric Drives Slovenija d.o.o.</b><br>Polje 15<br>5290 Šempeter pri Gorici |
| <b>PROTOTIPNI VZOREC / PROTOTYPE</b> <input type="checkbox"/>  |   |
| <b>PPAP VZOREC / PPAP SAMPLES</b> <input type="checkbox"/>   |   |
| <b>NOVA SPREMEMBA (1. serija) / NEW ENGIN.CHANGE (1<sup>st</sup> batch)</b> <input type="checkbox"/> |   |
| Kontaktna oseba<br><i>/ Name of contact</i>  | <input style="width: 150px; height: 20px;" type="text"/>  |
| Tel. št.<br><i>/ Phone</i>   | <input style="width: 100px; height: 20px;" type="text"/>  |
| Koda materiala / Part number : .....   |   |
| Naročilo / Order : .....   |   |
| Št. spremembe / Engineering change : .....   |   |
| Količina<br><i>/ Quantity</i>  | <input style="width: 150px; height: 20px;" type="text"/>  |
| Vzrok / Motive .....<br>.....  |   |
| Obr.: P. 224/1   |   |

Furthermore, the supplier must mark special deliveries that are subjected to quality control with the yellow label. The next yellow label must be applied by the supplier in such cases:

|  |                      |   |                      |
|--|----------------------|---|----------------------|
| <b>DOBAVITELJ / SUPPLIER</b>   |                      | <b>PREJEMNIK / RECIPIENT</b>                  |                      |
|  |                      | <b>MAHLE Electric Drives Slovenija d.o.o.</b> |                      |
|  |                      | Polje 15<br>5290 Šempeter pri Gorici          |                      |
| <b>POSEBNA DOBAVA / SPECIAL LOT</b>  |                      |   |                      |
| Kontaktna oseba<br><i>Name of contact</i>  | <input type="text"/> | Tel. št.<br><i>Phone</i>                      | <input type="text"/> |
| Koda materiala<br><i>Part number</i>   | : .....              |   |                      |
| Št. spremembe<br><i>Reference</i>  | : .....              |   |                      |
| Količina<br><i>Quantity</i>  | <input type="text"/> | Vzrok<br><i>Motive</i>                        | .....                |
| <input type="checkbox"/> 100% OK potrjeni kosi / 100 % OK certified parts<br>Specifikacija po risbi / <i>Print requirement</i> .....<br>Metoda preverjanja kakovosti / <i>Checking method</i> .....    |                      |   |                      |
| <input type="checkbox"/> Kosi NOK in odobritev / <i>Parts NOK and approved</i><br>Specifikacija po risbi / <i>Print requirement</i> .....<br>Dejanska dimenzija / <i>Actual dimension</i> .....        |                      |   |                      |
| <input type="checkbox"/> 100% OK kosi po zaključenih korektivnih ukrepih (2 pošiljki) reklamacije:<br>100% OK parts after final corrective action implementation (2 shipments) .....<br>Obr.: P. 225/1 |                      |   |                      |

## 6.2 Marking - labelling manipulation and packaging units

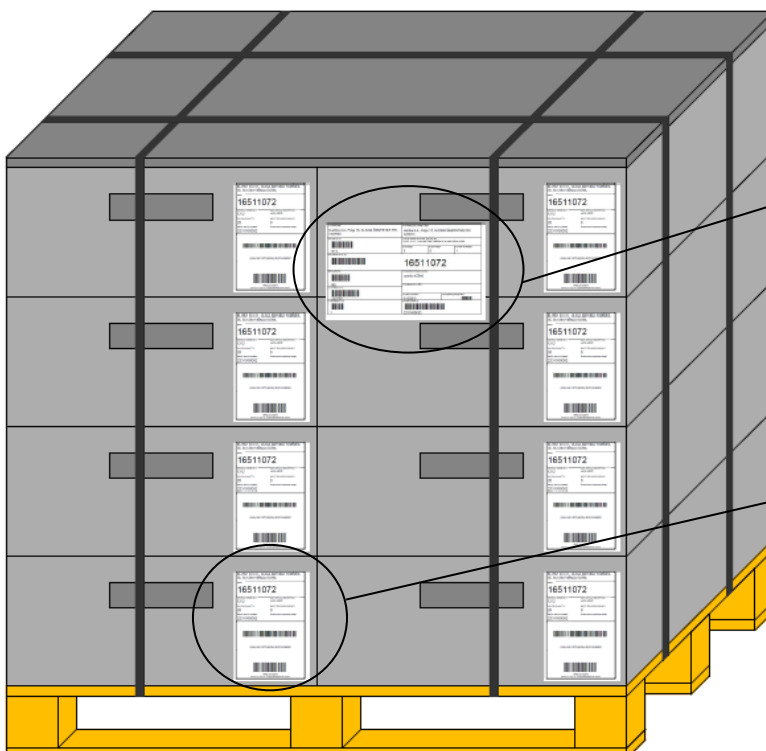

**ODETTE label**, transportation label – we mark the entire contents of a manipulation unit. The label contains data based on the standard.

**Logistic label**, we mark the contents of one packaging unit.



### 6.3 Marking mixed manipulation and packaging unit

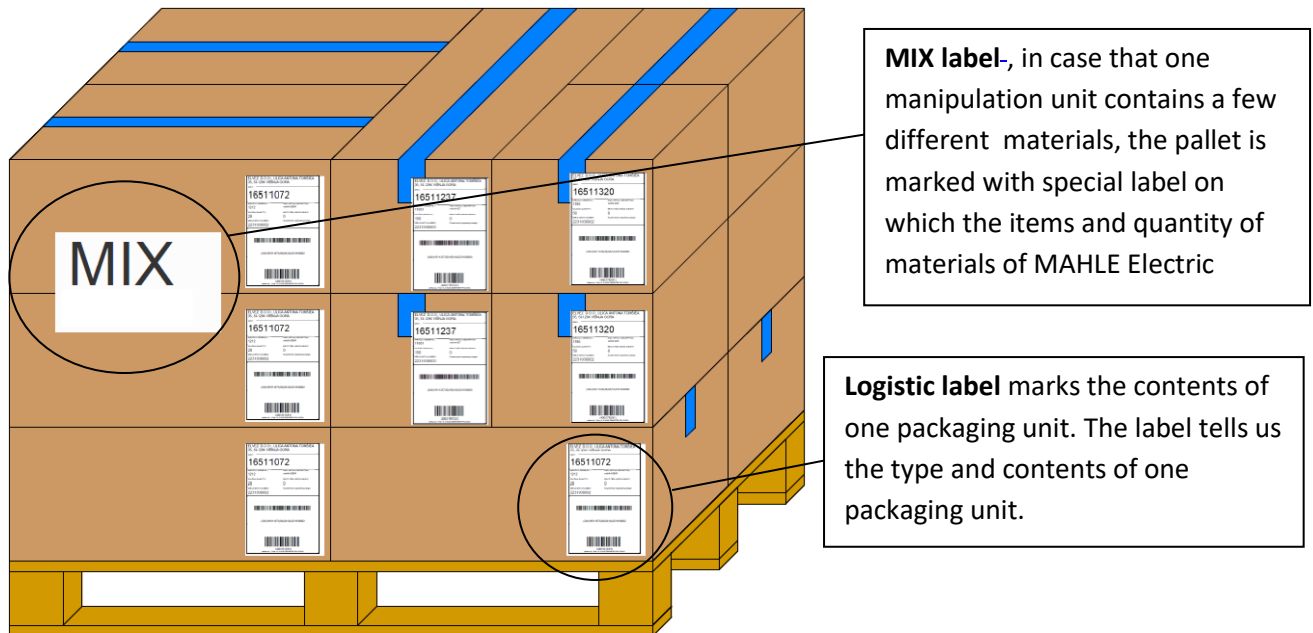

### 6.4 Programme for labelling manipulation and packaging units

Instructions for printing proper labels for packaging units material's for delivery to MAHLE Electric Drives Slovenija are hereinafter. We have two types of labels: Odette label and logistic label. Both are in accordance with the standards.

Computer programme helps a supplier to make correct labeling of goods/packaging units with accordance to the applicable standards.

Odette label is made by the Odette standard which is used most in the automotive industry, while the logistic label is made by the recommendations of EAN Slovenia (based on recommendations of EAN International) and is suitable for a common use.

Labels are designed to allow you gathering data from processes that take place throughout the supply chain (takeover, storage, control, various manipulations) with the use of a barcode reader. The read data are unambiguous, so that the contents are automatically detected, which greatly reduces the possibility of data entry errors.

Conditions for use of the programme are running Microsoft Windows (98 or newer versions) and Microsoft Office Excel (tested, works with 2000 or newer versions).

### 6.4.1 Fonts installation

First we install fonts which allow us barcode printing.

Fonts are in the mail .

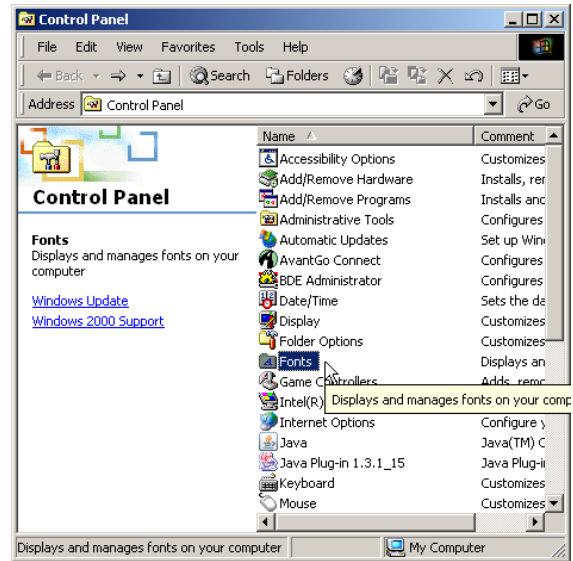

### 6.4.2 Programme installation

The programme does not require special installation, we just have to copy and paste it to the hard disk. In the folder we find the file »labels.xls« and copy it to the hard disk.

We then create a shortcut on the desktop.

### 6.4.3 Programme description

We start the programmer by double-clicking on the icon of the programme or the shortcut.

| Name   | Date modified    | Type                  | Size     |
|--|------------------|-----------------------|----------|
|  Labels.xls | 14.10.2015 15:06 | Microsoft Excel 97... | 1.130 KB |

On startup we enable macros.

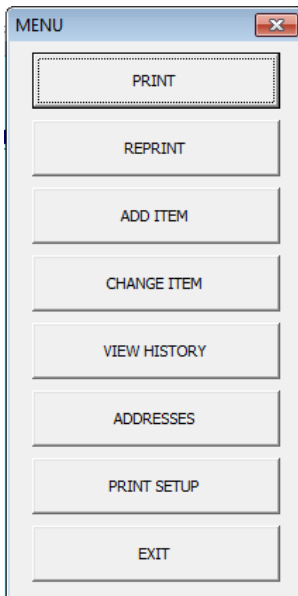
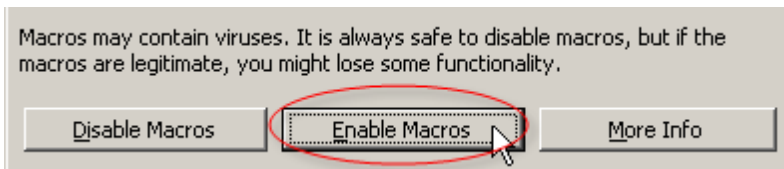

Then a menu opens where we can do further actions.

#### 6.4.4 Address check

MAHLE Electric Drives Slovenija 's and the supplier's addresses are already written in the Excel file, which is used in printout of the labels. In case you change the address or MAHLE Electric Drives Slovenija 's address is changed, all the addresses in the table in the system are changed. In this case you open the tab »Addresses« which opens a new window where we can change

the current address.

## 6.4.5 Printing

For printing labels we choose »print«, which is located in the main menu in the programme. A new window opens with few fields which have to be filled in. The fields coloured in red are obligatory, whereas the green fields can be filled in optionally. The first field requires ident number, then we have quantity on one label. The programme calculates net and gross weight by itself from the quantity on the label filled in the second box. We can also fill in this information ourselves. In the field »date of production« the date displays automatically, which can also be changed. Batch number is not required, because the programme generates it automatically, based on the previous batch number (numbering is according to the last four numbers and is encoded in the programme according to the rules in MAHLE Electric Drives Slovenija ).

The screenshot shows a window titled "LABEL" with the following fields and values:

|                       |            |
|-----------------------|------------|
| IDENT. NUM.           | 335020131  |
| QUANTITY PER LABEL    | 10         |
| NUM. OF LABELS        | 1          |
| WHOLE QUANTITY        | 10         |
| NET WEIGHT            | 0.01       |
| GROSS WEIGHT          | 0.01       |
| DATE OF PRODUCTION    | 10/15/2015 |
| BATCH                 | 123456     |
| ENGINEERING CHANGE N. | 23d        |
| ORDER NUM.            | 1600002549 |

At the bottom of the window are two buttons: "PRINT" and "BACK".

The screenshot shows a window titled "SELECT LABEL" with a list of label types and buttons:

- ODETTE (selected)
- LOG
- LOG x4
- BACK
- EXIT

When we have filled in all the fields correctly, we click on the tab »print«. Then a new window displays in which we choose the label type we want to print (Odette or logistic label).

We click on the selected label.

Afterwards the fulfilled label and window for printing is displayed. The window is

shown below.

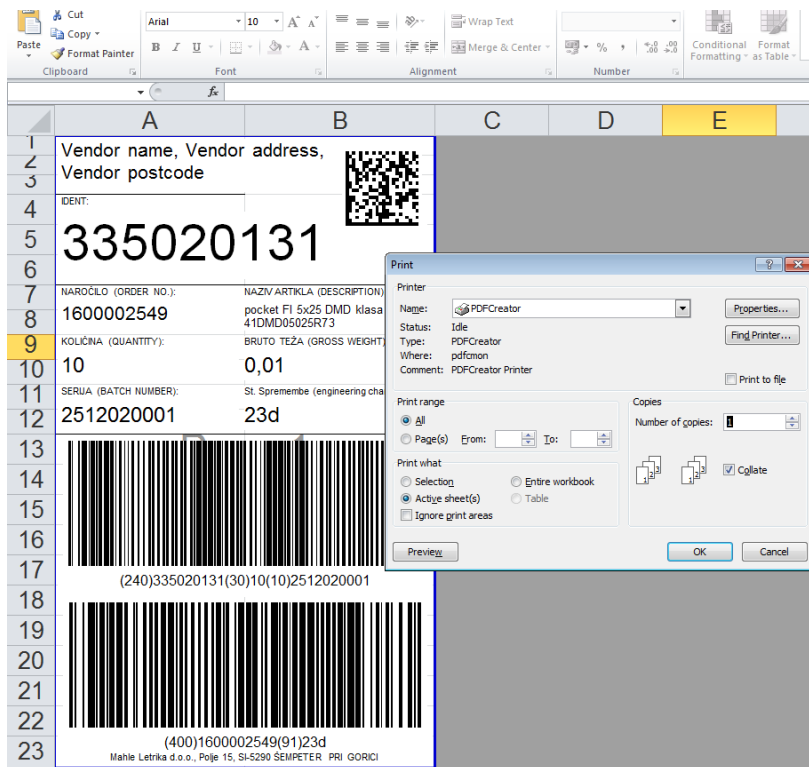

All we have to do is choose the printer to print the label and then click OK. We can also check the quantity of labels to be printed, but this is by default transferred from the printing window, where we have determined the quantity (we can also change this - the field is coloured in red). Please, pay special attention to some programme bug in Excel where you must not choose »preview« before printing, because the programme will freeze.

### 6.4.6 Reprinting

In case we want to repeat the pre-printed label, we choose »reprinting« in the main menu. In the new window we select (field ITEM), in which we can select labels from the last printed backwards.

After selecting the number of the item, we click on »PRINTING« and a new window opens with the box filled in with parameters we had printed with the label before. The procedure is always the same as described above.

### 6.4.7 Entry of a new material code

Entry of a new material ident that does not exist yet is possible with a click on » add new ident« in the main menu of the programme. After clicking on this button, a new window appears which requires filling in new data for this material.

Standard values for MAHLE Electric Drives Slovenija are:

- Order number (field ORDER NUMBER: ten-digit number starts with 15 or 16)
- Ident number (field IDENT No.: for raw materials, many digits numerical value)
- Net weight / piece (kg)
- Drawing number (field DRAWING No.- we add a number of actual valid drawing number in the field, by which goods are purchased.
- EAN (field EAN - in case the supplier has EAN number, he shall enter it - according to this number the goods are taken over.

After we have entered all the fields we click »ENTER« and data is entered to the Excel file. Material is in the list for printing a label.

### 6.4.8 Correcting the current ident data

If we want to correct the current material ident, which has been added on the list of materials, we have to click »correct« in the main menu. Similar, when we enter a new ident, a new window appears in which we must first complete the field with IDENT No. or select it from the previous entering. Then we change the fields we want to be different and click on »CORRECT«.



### 6.4.9 History overview

|    | A     | B                 | C          | D                 | E               | F    | G    |
|----|-------|-------------------|------------|-------------------|-----------------|------|------|
|    |       | MENU              |            | IZHOD             |                 |      |      |
| 1  | STPOS | 1SHIPTOPARTY      |            |                   | 2UNLOADINGPOINT |      | 3D   |
| 2  |       | NAZIV             | ADD1       | ADD2              | NAZIV           | ADD1 | ADD2 |
| 3  | 4     | MAHLE EI Polje 15 | SI-5290 Št | MAHLE EI Polje 15 | SI-5290 Št      | 15   |      |
| 4  |       |                   |            |                   |                 |      |      |
| 5  |       |                   |            |                   |                 |      |      |
| 6  |       |                   |            |                   |                 |      |      |
| 7  |       |                   |            |                   |                 |      |      |
| 8  |       |                   |            |                   |                 |      |      |
| 9  |       |                   |            |                   |                 |      |      |
| 10 |       |                   |            |                   |                 |      |      |
| 11 |       |                   |            |                   |                 |      |      |
| 12 |       |                   |            |                   |                 |      |      |
| 13 |       |                   |            |                   |                 |      |      |
| 14 |       |                   |            |                   |                 |      |      |

If we want to overview the history of printed labels, we have to click on »history« in the main menu. That puts us into the Excel sheet »H«, where we can see the history of all printed labels for the past three months. Labels that were printed more than 3 months ago are deleted automatically due to too many data on the list.

If we want to go back from the Excel sheet to the main menu, we must click on »MENU«, which is located on the top of the history overview sheet.

### 6.4.10 Correcting output settings

Both types of labels( Odette and logistic) have some settings that can be done before printing. In case the printed label is not good and you want to change the paper size or make larger fonts or even make a bigger label, you can do it by clicking on the »output settings« in the main menu.

The screenshot shows a 'PRINT SETUP' dialog box with the following settings:

- ODETTE LABEL:** PAPER SIZE is A5, ZOOM is 120%.
- LOG. LABEL:** PAPER SIZE is A5, ZOOM is 150%.

Buttons at the bottom: SAVE, BACK.

A new window opens where you can choose from two paper sizes (A4 and A5) and label enlargement on paper. When you change the setup you have to save the entered by clicking »SAVE«.

### 6.4.11 Exit programme

By clicking on tab »EXIT« in the main menu, the sheet is saved and closed.

### 6.4.12 Error types

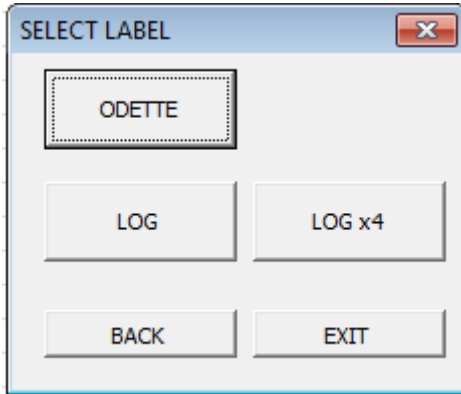

With this programme we can print ODETTE or logistic labels that are designed to identify manipulation and packaging units.

#### 6.4.12.1 ODETTE label

We mark the contents of the manipulation unit - transportation label.

|   |  |   |                             |
|---|--|---|-----------------------------|
| (1) ship-to party<br>MAHLE Electric Drives Slovenija, Polje 15, SI-5290 ŠEMPETER PRI GORICI |  | (2) unloading point - storage - usage<br>MAHLE Electric Drives Slovenija, Polje 15, SI-5290 ŠEMPETER PRI GORICI |                             |
| (3) order no. (K)<br>1634567890   | (4) vendor address (short name, plant, ZIP, city)<br>NAZIV, ADD1, ADD2 |   |                             |
| (8) customer ref. no. (P)<br>987654   | (5) net weight<br>987654000  | (6) gross weight<br>98765400  | (7) number of packages<br>1 |
| (9) quantity (Q)<br>987654  | (10) description of delivery, service<br>pokrov                        |   |                             |
| (12) vendor no. (V)   | (11) supplier ref. no. (305)<br>x5789                                  |   |                             |
| (15) package no. (S)<br>1   | (13) date of production<br>6/12/2015                                   | (14) engineering change status<br>12345678  |                             |
|   | (16) batch number (H)<br>123ewdwf                                      |   |                             |

### 6.4.12.2 Logistic label

We mark one packaging unit.

|   |   |   |
|---|---|---|
| Vendor name, Vendor address,<br>Vendor postcode                                       |   |  |
| IDENT: _____  |   |   |
| <b>335020131</b>  |   |   |
| NAROČILO (ORDER NO.):<br><b>1600002549</b>  | NAZIV ARTIKLA (DESCRIPTION):<br>pocket FI 5x25 DMD klasa F<br>41DMD05025R73 |   |
| KOLIČINA (QUANTITY):<br><b>10</b>   | BRUTO TEŽA (GROSS WEIGHT):<br><b>0,01</b>                                   |   |
| SERIJA (BATCH NUMBER):<br><b>12345</b>  | St. Spremembe (engineering change):<br><b>23d</b>                           |   |
|      |   |   |
| (240)335020131(30)10(10)12345   |   |   |
|     |   |   |
| (400)1600002549(91)23d<br>Mahle Letrika d.o.o., Polje 15, SI-5290 ŠEMPETER PRI GORICI |   |   |

## 7 PROCESS OF MANAGEMENT OF RETURNABLE PACKAGING

Returnable packaging can be in the ownership of MAHLE Electric Drives Slovenija or a supplier. There are some rules for managing a returnable packaging written below.

### 7.1 MAHLE Electric Drives Slovenija provided packaging

#### 7.1.1 Loop size calculation

Calculation of the number of packaging unit is the basics for management of returnable packaging. MAHLE Electric Drives Slovenija will calculate the number of the packaging needed for all the suppliers.

The formula below is MAHLE Electric Drives Slovenija 's standard formula for calculating the number of packaging in accordance with management in the

business.

### 7.1.2 Formula and parameters for calculation

- Existing supply plan:

$$N = \frac{\sigma_d + Qd_{povp} * t_{dob} * t_{osk} + Qzalpovp}{Qemb}$$

- Calculation for developing supply plan:

$$N = \frac{Qd * t_{dob} * t_{osk} + Qzaln}{Qemb}$$

#### Legend:

**N** – Packaging quantity

**Qs<sub>povp</sub>** – Average lot size

**Qs** – lot size

**Qd<sub>povp</sub>** – Average consumption per day

**Qd** - consumption per day

**σ<sub>d</sub>** – Standard deviation per day in U/M

**Qemb** – quantity of materials in one packaging unit

**t<sub>dob</sub>** – delivery time in days (transportation + takeover + lead time in days, when packagings are at a supplier (example: in case the packaging is in use at the supplier just for packing on the last operation, we have to use 1 day+ shipping wait time)).

**t<sub>osk</sub>** – time of supply of packaging units in days (transportation + order or recall; this time is 1 day for the Slovenian suppliers)

**Qzalpovp** – average stock

**Qzaln** – safety stock, we estimate it (explanation below).

### 7.1.3 The procurement and financing of returnable packaging

After making an agreement in terms of technology for returnable packaging, the production Logistics of a PE will give the necessary quantity for purchasing it (optional purchase salesman for central warehouse purchases or production programme manager if a BU does not have production logistics department).

Purchase salesman makes an agreement with the supplier on percentage of financing the purchase of returnable packaging.

The first demand for purchase by supplier is carried out by the department TEH-PRTLPL. For the next purchase of the same packaging, acquisition offer is made by the business organizer for packagings.

### 7.1.4 Delivery packagings to supplier

MAHLE Electric Drives Slovenija keeps the status of sent packagings to the supplier. All movements of packagings are guided by quantity and by ident number. MAHLE Electric Drives Slovenija also makes visual inspection of eventual damages on the packaging before delivery and excludes it from delivery and replaces it with a good one.

### 7.1.5 Supplier's packagings takeover

The supplier must check all returnable packagings upon delivery. The quantity and possible damages must be checked. If there are some issues, the supplier must provide the information to the responsible person in MAHLE Electric Drives Slovenija. MAHLE Electric Drives Slovenija will solve the problems as soon as the information is provided.

### 7.1.6 Packagings status supplier

The supplier is responsible to manage his own status of the packagings inventory. Any discrepancies shall be reported to MAHLE Electric Drives Slovenija. MAHLE Electric Drives Slovenija will see its own inventory of packaging and will reply to supplier.

The supplier is financially responsible for unjustly missing packaging.

If a supplier damaged the packaging, he must pay for it or replace it with a new one.

Certain packagings are worn out and damage can occur for this reason. MAHLE Electric Drives Slovenija will take note of this and will write-off such packaging (no

cost for the supplier).

### 7.1.7 Inventory

The supplier is responsible for making inventory of MAHLE Electric Drives Slovenija returnable packagings once a year.

MAHLE Electric Drives Slovenija will send the inventory list for returnable packagings. Based on the list, the supplier makes inventory and sends the list back to MAHLE Electric Drives Slovenija .

In case some packaging units are missing, MAHLE Electric Drives Slovenija will consider the reason and possible financing of the missing or damaged packaging.

### 7.1.8 Hygiene of returnable packaging

Supplier shall keep the hygiene of the returnable packaging, unless MAHLE Electric Drives Slovenija and the supplier have reached a different agreement.

The supplier must pay attention to cleanliness of the packagings. Some materials that are used on production lines in MAHLE Electric Drives Slovenija become useless if in touch with filth.

## 7.2 Supplier's packaging

MAHLE Electric Drives Slovenija will calculate the necessary quantity of packagings as described above.

In order to prevent incorrect inventory and consequent lack of packagings, the supplier shall manage the status list correctly and make inventory once a year.

Regardless of the ownership, it is the supplier's responsibility to maintain order and hygiene of packagings.

## 8 AIR FREIGHT

### 8.1 Introduction

To ensure damage-free transportation shipments must be properly packed . There are some pointers written bellow, just to understand the meaning and importance of proper packaging for damage-free air freight movements.

## 8.2 Hazards of distribution

**Punctures and abrasion:** Occur when package comes in contact with other packages during the shipping process.

**Compression:** happens when external forces damage faces, sides or corners of a package.

**Environmental exposures :** packagings are exposed to high and low pressure and temperatures that may have effects on packages and products. There are also others, such as dirt, dust , precipitation. A shipper must consider these hazards to avoid damage to product and packages.

**Shipment handling:** Usually the packaging is handled with a forklift and it is common that impacts associated with handling operations occur. Proper cushioning can reduce damage that may occur.

**Vibration:** Proper cushioning can absorb the negative vibrations when handling, transporting and forklifting.

## 8.3 Marking and labelling shipments

All air freights must be properly labelled. A label must be durable and must consist of a name, address, shipper and consignee. It also has to be clearly visible. Below there are a few examples of markings commonly used.

### DO NOT FORK



### KEEP DRY



### FRAGILE



### DO NOT TOP LOAD



### TOP HEAVY



### CENTER OF GRAVITY



## 8.4 Cardboard cartons

Cardboard cartons are the most common type of shipping containers. We must know the strength and weakness of these containers to have damage-free shipments.

This type of material loses strength in about six months. In addition, humidity and moisture weaken cartons and we cannot reuse it anymore.

A tape is most common for closure of carton boxes and improper application can cause closure failure. Use quality packaging tape designed specifically for sealing carton boxes.

## 8.5 Pyramid-shaped loads

Pyramid shaped loads are one of the biggest packaging problems in the industry. They do not provide level surface on top and therefore can cause damage to other shipments. Shipments packed in such way can cost more. We must avoid such shipment packaging.

## 8.6 Wood packages

Wood packages allow safe, damage-free transit if it is done properly using quality lumber.

Use plywood and not oriented strand board (OSB), medium density fiberboard (MDF) or particleboard.

Fasteners should not be located in knots or other defective areas of the wood. Use diagonal braces on each panel to increase the strength of a wooden box.

## 8.7 Air freight pallets

We use mainly wooden and plastic pallets for air freights. Pallets should be high quality to reduce damages according to forklifting and manual handling. Pallets also have to be: large enough to accommodate shipments without overhang, damage



free without any nails out of the pallet. We also must not exceed the maximum capacity of the pallet.

Plastic pallets are an alternative to wooden pallets. They are very durable and they can be reused many times. On the other hand they are very expensive.

## 8.8 Dunnage

One big problem with shipments is empty spaces in carton boxes and other containers. Empty spaces can cause material movements and therefore possible damages and breaks. So we must use dunnage that can be simple rolled-up paper, wood inserts or blocks or custom wraps and foam.

## 8.9 Cushioning

During shipments many transportation operations take place. Because of this, products require cushioning for protection against vibrations and shocks from the time of the pickup to the final delivery. Cushioning must absorb multiple shocks.

## 8.10 Stretch wrapping

Stretch wrapping is a common and effective method of keeping boxes and containers together. The stretch wrap must be applied correctly: around the pallet and then continued around the load and upward.



# MAHLE

